

INSTALLATION INSTRUCTIONS

This garage door has been designed to be as easy as possible to use, service and automate when installed correctly. Please therefore take time to read these instructions fully before beginning any work. Note: This door has been designed to hang on a 70mm x 70mm timber goalpost frame (not supplied).



CAUTION

IMPORTANT INFORMATION

- 1 This garage door is intended for domestic use only.
- 2 Garage doors are heavy and may have sharp edges. Wear protective gloves. Installation should not be undertaken alone. Care must be taken when handling.
- 3 Ensure the door is continuously supported before it is secured and avoid installing in windy conditions.
- 4 Do not attempt to install or adjust this door if you are unsure of any of the instructions below.
5. Wear eye protection.

BEFORE COMMENCING WORK

1 Remove all wrapping

Before starting: remove all wrapping and check door has been supplied with correct lifting gear kit. Kit code is on identification label on reverse of door.

2 Check opening size

Before fitting door, check opening size and squareness of timber frame. The door is made smaller to give correct clearance within the frame.

3 Check headroom

There must be a minimum of 51mm headroom above lower face of top timber or lintel. This must reach back into the garage for at least 1865mm.

4 Check the "goalpost" frame

The "goalpost" timber frame should be a minimum of 70mm x 70mm square (2 3/4" x 2 3/4"), in **good condition** and securely fixed to the surrounding structure.

5 Tools

All the initial fitting work is done from inside the garage, so all tools and parts should be to hand there before door is placed in opening.

You will need:

- | | | |
|--|--------------------------|--|
| ● 6mm & 10 mm flat bladed screwdriver | ● 7mm A/F socket/spanner | ● Engineer's pliers |
| ● No 2 & 3 posi-drive screwdriver | ● Protective gloves | ● 19mm x 19mm timber weatherbead to fit under the head of the door frame (for all doors except Heritage) |
| ● Drill and 2.5mm drill bit (for pilot holes) & 9 mm drill bit | ● Sharp knife | ● 70mm x 70mm timber goal post frame |
| ● 13mm A/F socket/spanner | ● Tape measure | ● Wedges (packing pieces) |
| ● 10mm A/F socket/spanner | ● Hammer | |
| | ● Grease | |

Note to installer: Please ensure that this instruction sheet remains with the door for the owner's future reference.

1

CAUTION ! Please ensure all tools and parts are **inside** the garage before the door is placed in the opening.

FITTING YOUR DOOR

Assembly diagram (numbers refer to installation notes)

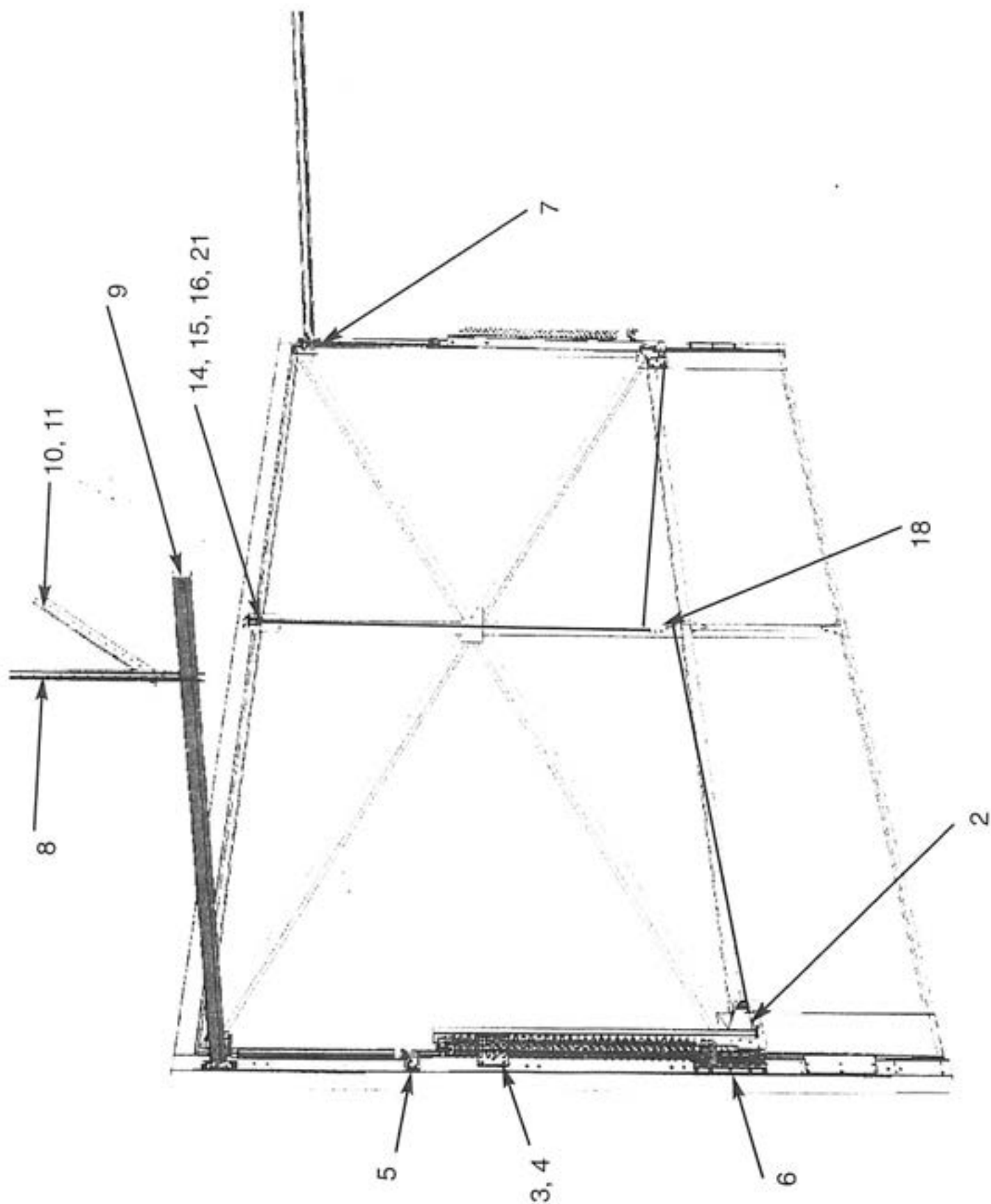

IMPORTANT NOTE

Prior to Fitting the Door

For ease of transportation and storage some doors are supplied without the upper weather strips attached to the door panel. These are supplied separately within the door fixing pack. If your door is of this type then fit the weather strips as shown below using 5 off No. 12 x 3/4" self tapping screws per side

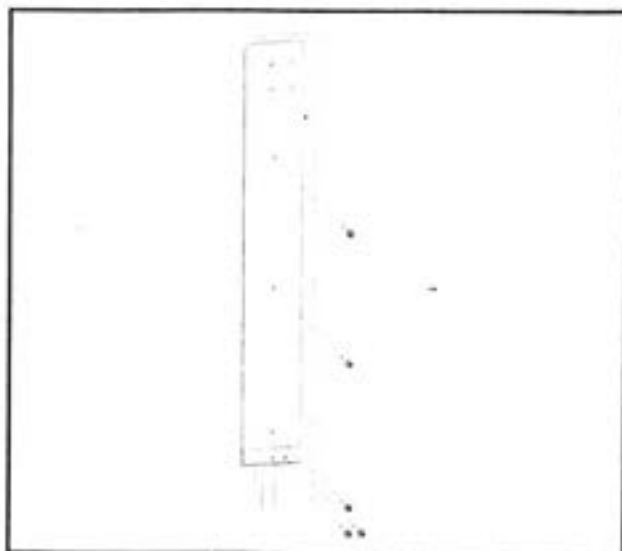

Door Installation

- 1 Stand door, safely propped, centrally between side jambs on three pieces of 12mm. (1/2") packing. Ensure the gap between the top of the door and the underside of the lintel is even and not less than 12mm. (1/2").
N.B. For doors measuring 70 mm thick the gap should be 15mm.

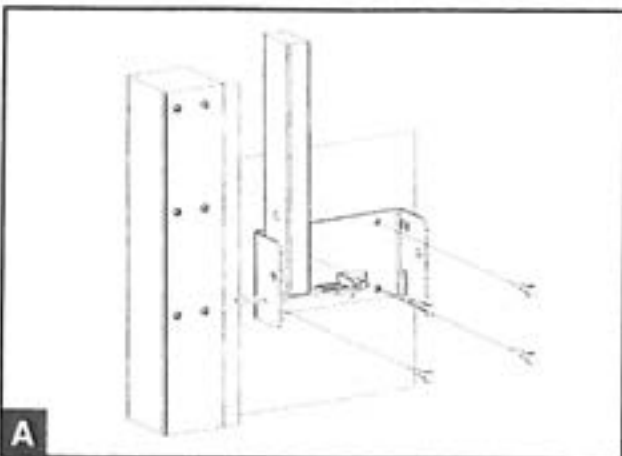

- 2 Fit pivot arms to plates in bottom corners of door using four No. 14 x 3/4" Hex head self-tapping screws per side (See Figure A).
- 3 Swing the pivot arms up, align three holes in each lower side seal with those in main pivot brackets. Ensure lip on lower side seal locates against the side jamb for the full length of the seal.
NOTE: for special sized doors the bottom of side seal must be cut short to suit installation.

- 4 Fitting main Pivot Brackets
Option 1
(Standard Double Door Gear upto 90 kgs)

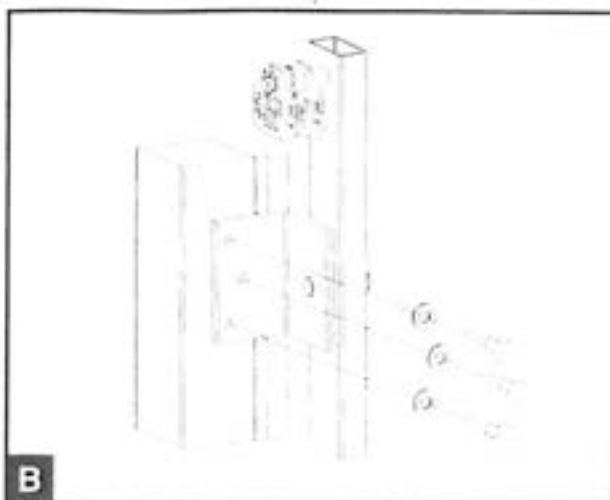

Drill pilot holes and secure each main pivot bracket in place using three M8 x 50mm coach screws and M8 washers per side. (See fig B).

- Fitting main Pivot Brackets
Option 2
(Heavy Double Door Gear over 90 kgs)

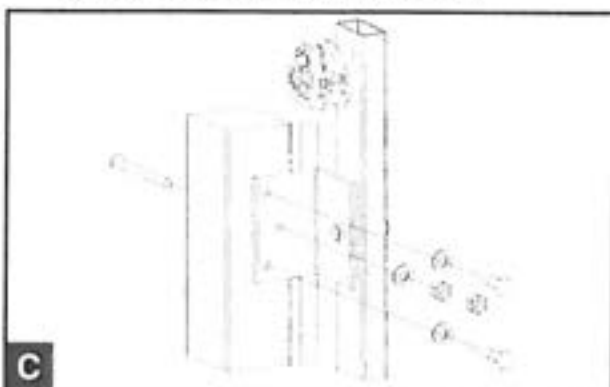

Drill pilot holes and secure each main pivot bracket in place using two M8 x 50mm coach screws and M8 washers per side. (See fig C).
Drill through centre fixing hole through side jamb using 9 mm drill bit. Secure in place using M8 x 90 mm coach bolt through the timber and secure internally using 2 M8 nuts and a washer (See fig C).

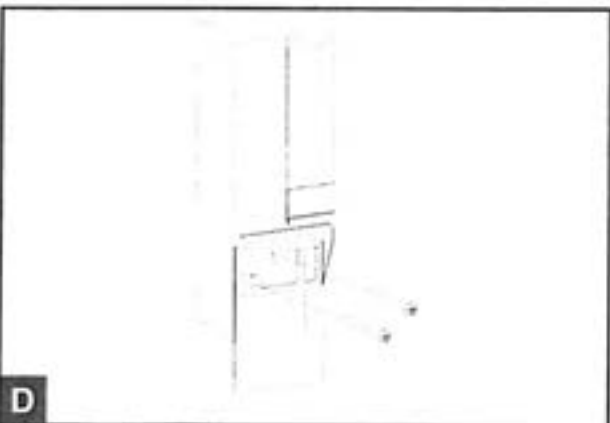

- 5 Smooth lower side seals into position. Align pivot blocks with holes in lower side seals as shown. (Fig. D) Secure using two no. 6mm x 50mm gold self tapping screws. There is no need to pilot drill for these screws.

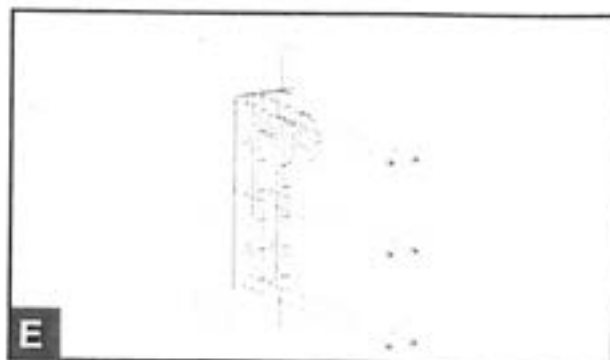

- 6** Smooth lower side seals in position, align holes in lower latch plate with holes in lower side seals. Place lower spring anchor brackets on top of latch plate once again aligning holes. Secure each bracket in place using three 6 mm x 50 mm gold self-tapping screws, pilot holes are not required. (See Fig E). Cut away flexible lower side seal locally where latch strikes the latch plate.

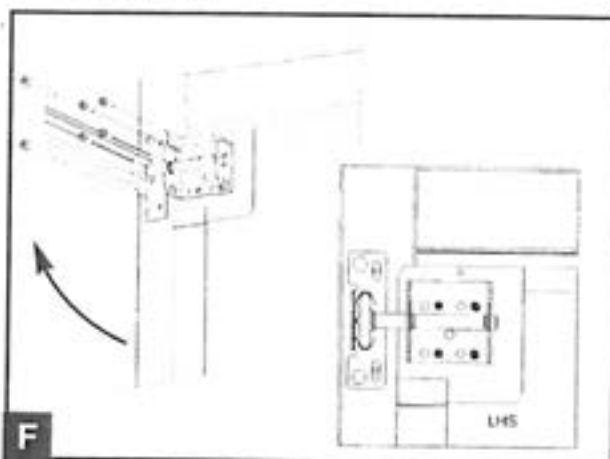

- 7** Fit each wheel bracket to top corner plate of door using four no.14 x 3/4" Hex Head self tapping screws ensuring two vertical slots in wheel bracket are facing downwards as shown (Figure F). Slide tracks over wheels and press firmly up and out in the direction of arrow until tracks are horizontal. Drill pilot holes in side jambs and secure each track fixing bracket using two no 12 x 1 1/2" self tapping screws and two M8 washers, ensuring wheel is in contact with the bottom of the track.

- 8** Slide track hangers over track ends as shown in main assembly diagram. Slide hangers to a convenient roof joist **within 200mm (8") from end of track** and fix hangers to joists using ONE N°12 x 1 1/2" self tapping screw only at this stage. For best results ensure tracks are horizontal, square to the frame and parallel to each other. At this stage the tracks should be able to swing sideways.

NOTE: With heavy double door gear intermediate track hangers and braces are supplied and should be used to create a mid point track fixing. Adopt same fixing procedure

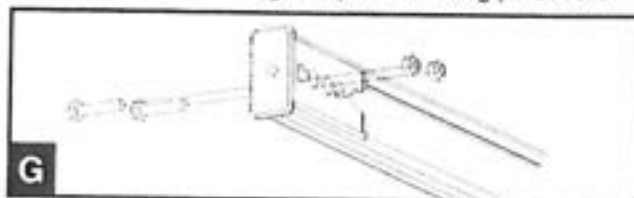

- 9** as with other hangers/braces. Slide track end bungs into position in orientation shown (see Fig. G). Secure each end bung to track using two M6 x 30mm hexagon head bolts, and two M6 nyloc nuts ensuring nut locates firmly into hexagonal recess in end bung

- 10** Fully open door and prop securely in position. With the door open, the tracks should be parallel. This can be checked by ensuring both roller wheels are in contact with the track end bungs. Bolt track braces to hangers using one M6 x 20mm hex head screw and one M6 nyloc nut per side. Fix each track brace to joist using ONE N°12 x 1 1/2" self tapping screw.

- 11** Lock each track hanger in position by fixing to joist using a second no.12 x 1 1/2" self tapping screw.

- 12** Establish gear setting positions for door from label attached to back of door. **Note** setting 1 is top anchor position

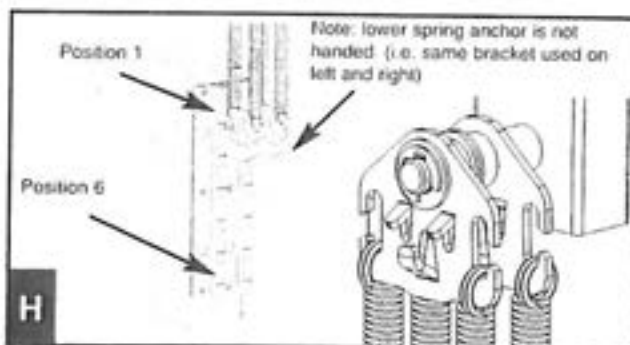

- 13** Still with the door in the open position and wearing eye protection fit lower spring anchors as shown and fit springs to spring anchors in orientation shown (See fig H).

Note Spring loops to be located on anchor bracket hooks facing outwards so that spring body is located in board of spring anchor brackets. When using centre hook spring will require twisting 180 degrees.

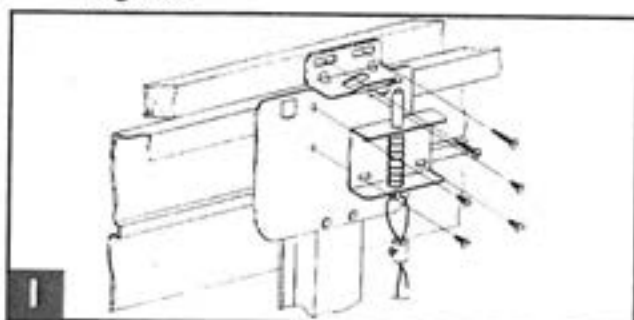

Always use both hangers on each side. For 2 springs use outer hooks, for 1 spring use centre hook, for 3 springs use all hooks. A minimum of 2 through to maximum of 6 springs per side maybe supplied depending upon door weight. Check door operation and re-tension if necessary. (See maintenance label on side seals for details).

NOTE - Some doors are supplied without the provision for a top latch to be fitted. In these instances the components outlined in instructions 14 to 16 will be surplus to requirements. If your door is of this type proceed to instruction 17.

- 14** Fit the top latch assembly into the pre-drilled holes on the top centre door bracket using 4 off N°10 x 1/2" self-tapping screws supplied (Figure I).

- 15 With the door closed, remove the park pin to release the latch pin (figure I). Align the catch bracket centrally over the latch pin with the lower face 3mm (1/8") above the top door bracket.
- 16 Insert 2 off N°12 x 1 1/2" self tapping screws through screws slots into head timber, use adjustment on screw slots to ensure correct alignment.
- 17 Open door half way and fit lock following the instructions in the lock pack supplied with your door.
- 18 From front of door ensure that lock handle is turned fully anti-clockwise From inside slide lock cam onto spindle in orientation shown

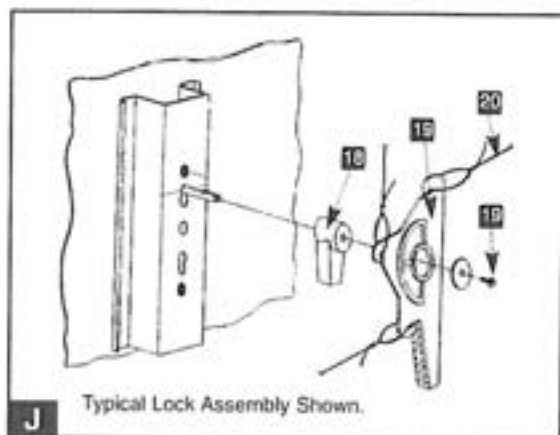

- 19 Fit lock lever onto lock cam as shown and secure to lock spindle using 1 off No.10 x 1/2" self tapping screw and washer. (See Figure J)
- 20 Locate looped ends of all latch cables securely in lever slots and adjust for correct operation

2 UPON COMPLETION

- 1 Fix lower side seals into position using five 1" clout nails per side.
- 2 Check door operation to ensure door opens and closes satisfactorily.
- 3 Check that lock and latches operate correctly.
- 4 Ensure all fixings are securely tightened
- 5 Fit 19mm x 19mm timber weatherbead to the underside of the top timber lintel (Fig M) except 70 mm thick doors.
- 6 Do not paint the spring or any moving parts.
- 7 Lubricate all moving parts/pivot points (refer to maintenance label for details) lubrication is an essential ongoing requirement to ensure the continuing smooth operation of your door.
- 8 Ask your professional Garage Door Specialist about remote controlled electric operators.

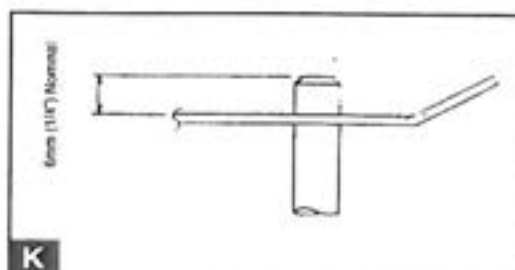

- 21 **ENGAGEMENT NOTE** On adjustment of top latch, please ensure a nominal 6mm (1/4") pin engagement through catch bracket (Figure K). Adjustment of all other latches should also be set to 6 mm latch overlap.
- 22

Check operation from inside garage to avoid being locked out

Doors over 7'6 High

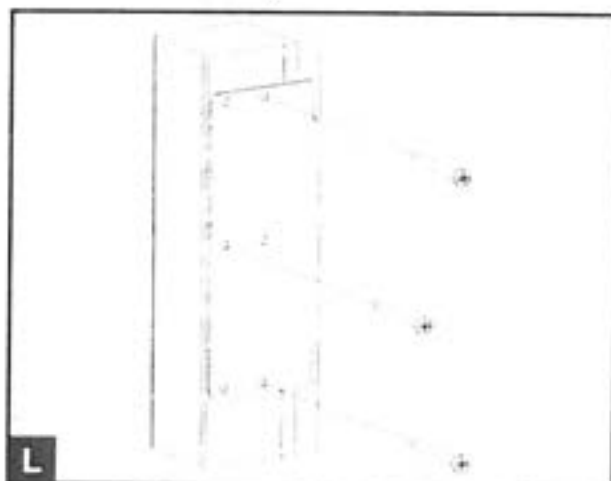

- 23 Doors over 7'6" in height (2286 mm) have an additional latch plate supplied which is secured close to ground level to provide additional wind load resistance. Align plate with the three holes pre-pierced in the lower side seal and secure using 3 off 6 mm x 50 mm gold self tapping screws per side (see Fig L) There is no need to pilot drill for these screws

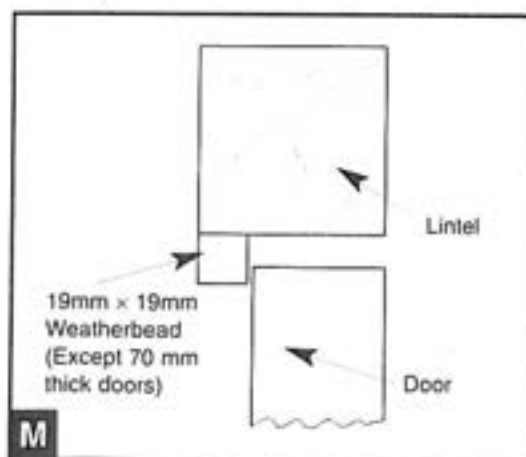

TROUBLE SHOOTING

- **DOOR IS HEAVY TO OPEN:**

Cause: Spring tension set too low

Solution: Re-set spring tension as detailed on the door maintenance label.

- **DOOR OPENS TOO QUICKLY:**

Causes: Spring tension set too high.

Solution: Re-set spring tension as detailed on the door maintenance label.

- **DOOR DOES NOT DELATCH:**

Cause: Latch cables may have been set too long.

Solution: If you are not locked out of the garage at the time, then the cables should be set to allow nominal 6mm latch engagement with the latch plates. If you are locked out of the garage, call your installer/supplier for assistance.

- **DOOR HANDLE FAILS TO TURN:**

Probable Cause: A jammed lock barrel.

Solution: Unfortunately this can only be remedied by a service call, however, this is not usually chargeable during the warranty period. Please contact your supplier for details.

- **KEY FAILS TO TURN IN LOCK:**

Probable Cause: Door handle has not been turned to the fully closed position.

Solution: Return the handle to the fully closed (horizontal) position and try again. If the problem still persists, contact your supplier.

- **LOST KEYS:**

Solution: Contact your supplier. The lock barrel will need to be replaced, but the method for doing this will vary. If you can get into your garage, the problem can be easily solved by removing the handle assembly from the door and replacing the lock barrel with a new one. If you are locked out, contact your supplier.

POWER OPERATION

This door is suitable for power operation. In order to conform with current legislation only independently tested and certified operators may be fitted. A list of approved operators is contained on the Declaration of Incorporation supplied with your door.

DISMANTLING INSTRUCTIONS

**THESE INSTRUCTIONS MUST BE FOLLOWED CAREFULLY
GARAGE DOORS ARE HEAVY AND AWKWARD TO HANDLE. ENSURE
ASSISTANCE IS AVAILABLE AND THAT SAFETY GLOVES ARE WORN.**

1. Fix all latches in the fully retracted position.
2. Open door and safely prop in the open position.
3. Remove springs from their hangers. (wear eye protection).
4. With assistance remove prop and close door slowly until fully closed.
5. Prop door in fully closed position and place packers beneath the door between base of door and floor.
6. Remove all track supports and remove track fixing screws from the frame and remove.
7. Remove fixings to main pivot brackets, door should now rest on packers.
8. Remove bottom door mounting brackets.
9. Remove main pivot blocks.
10. The door can now be carefully removed from the opening. Seek assistance in lifting.
11. If door is to be disposed of please do so in a responsible manner in line with the latest legislation applicable at the time.

In the event of difficulty please contact your local Garage Door Specialist or call our Garage Door Helpline.
See main CE label for details